



**JUPITER**

**Linear lighting system**



Jupiter is an efficient, flexible and versatile linear light system providing a lighting solution for various applications of industrial, commercial and office etc. It provides many lighting options with various luminaire elements, optics and functional modules to meet different lighting requirements. It saves time and costs due to its extremely easy and toolless installation and maintenance design.



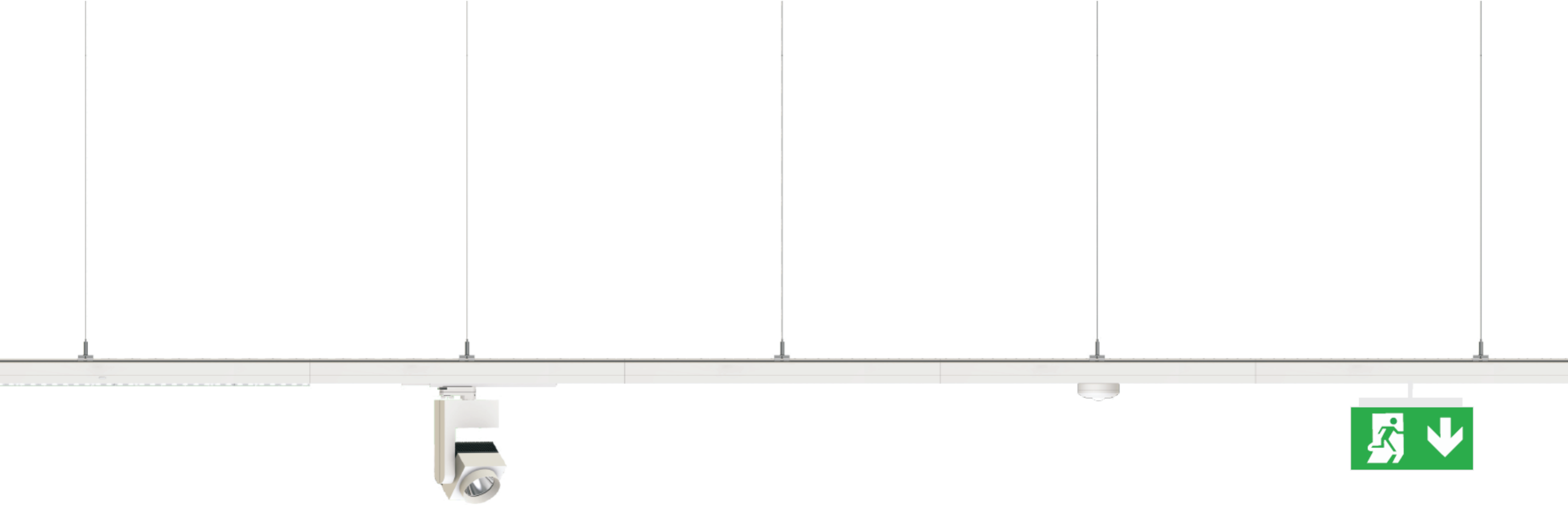

1

**Luminaire**

Various optics  
DALI or 1-10V dimming  
Battery emergency  
emergency for centre battery system

2

**Track module**

Standard 3 phase track rail integrated  
can be installed with track spot light  
for accent lighting

3

**Blank cover module**

PC or aluminum version  
installed at the position  
without luminaire

4

**Sensor module**

motion sensor  
lux control  
voice control  
group control

5

**Other functional module**

emergency light module  
socket module

## A CONTINUOUS LINE SYSTEM WITH INNOVATIVE DESIGN TO SAVE TIME AND COSTS.

Jupiter aims to minimize the installation time and costs with its extremely easy and toolless installation and maintenance design.

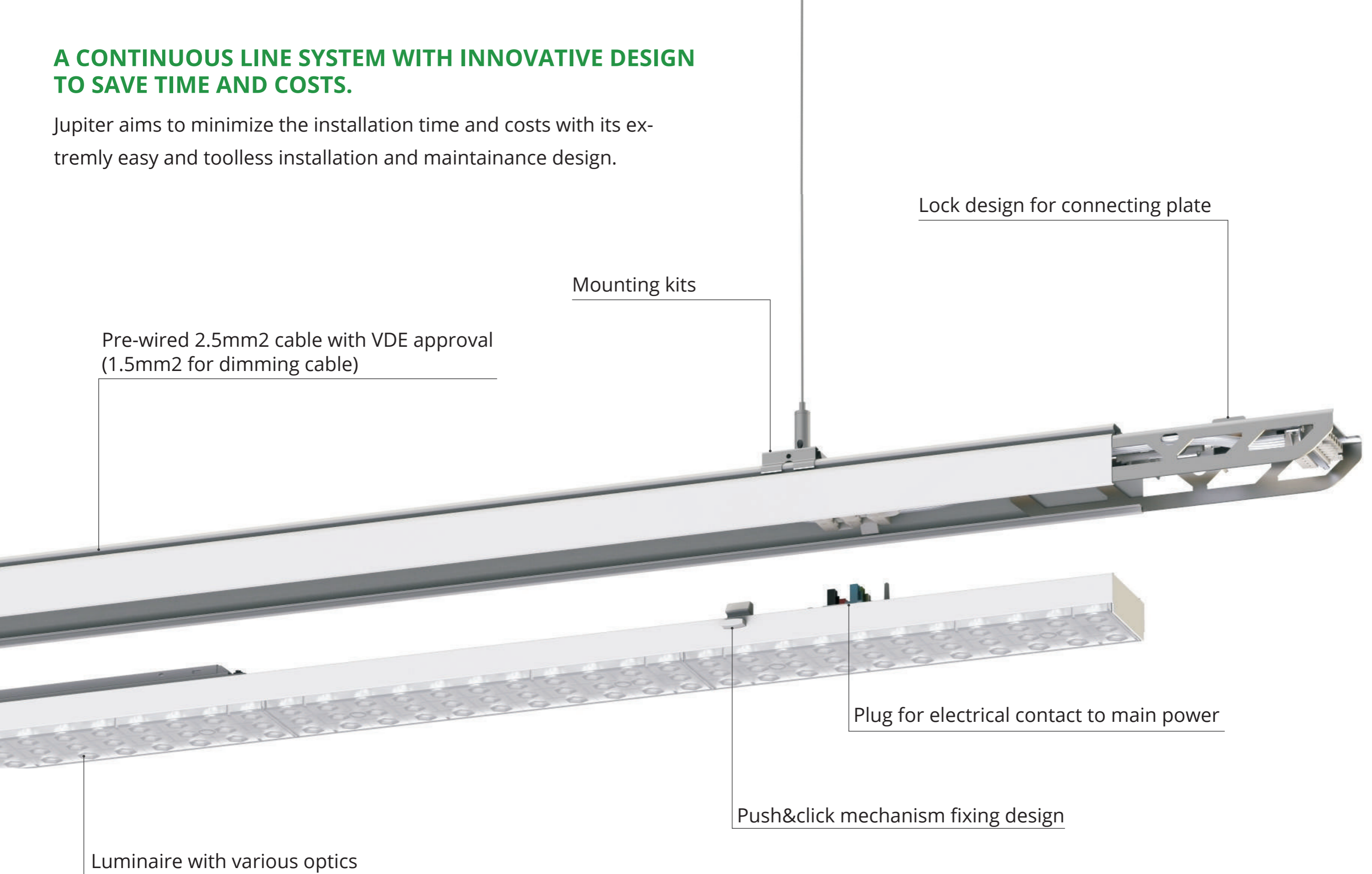

## ENDLESS CONNECTION AND LIMITLESS POWER FEEDING

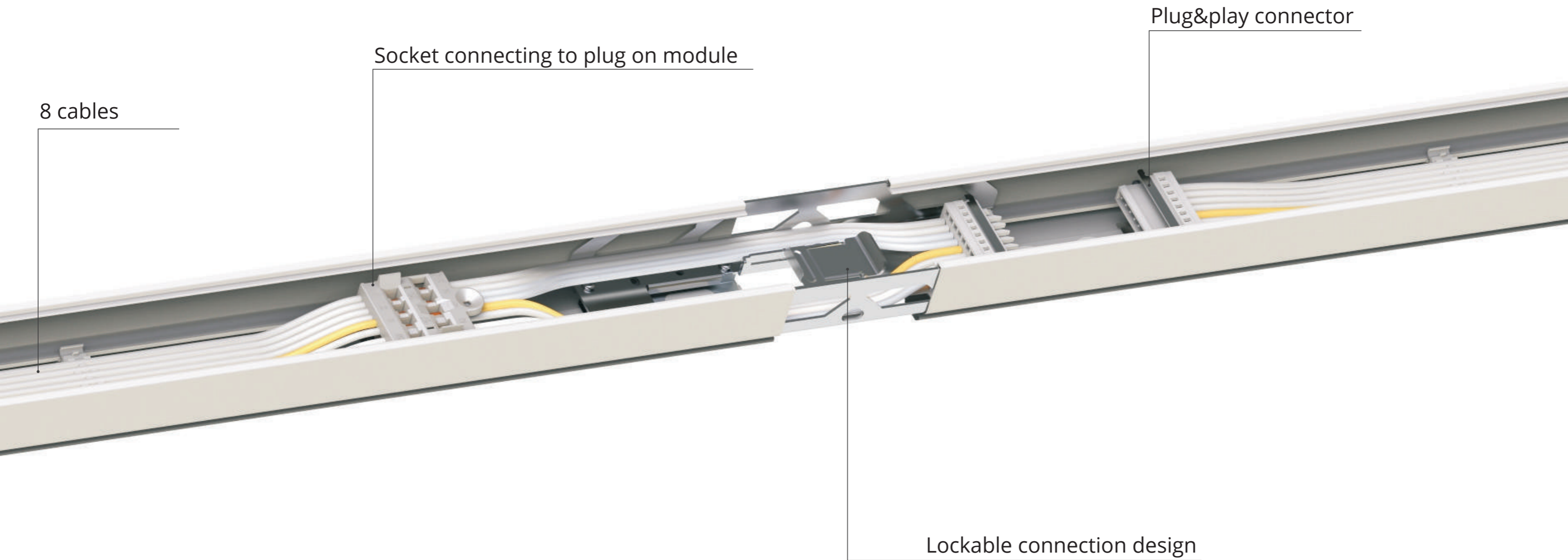

# OPTICAL LENS AND DIFFUSER DESIGN

30x110°

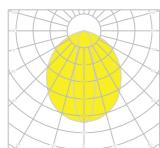

60x110°

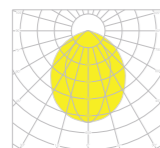

90x110°

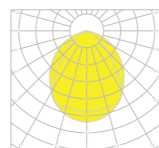

Asymmetric  
L or R

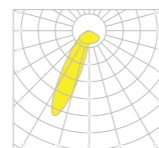

Double  
Asymmetric

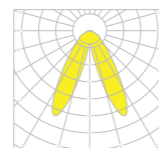

120°

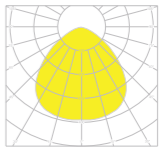





# JUPITER LUMINAIRES

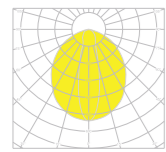

Model	CCT	Power	Beam angle	LM/W	L	W	H
276239	4000K	33-66W	30x110°	170lm/W	1530	67	25
276246	5700K	33-66W	30x110°	170lm/W	1530	67	25

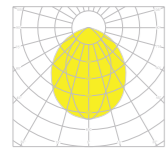

Model	CCT	Power	Beam angle	LM/W	L	W	H
276239	4000K	33-66W	60x110°	170lm/W	1530	67	25
276260	5700K	33-66W	60x110°	170lm/W	1530	67	25

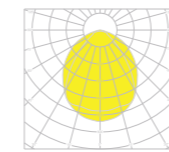

Model	CCT	Power	Beam angle	LM/W	L	W	H
276277	4000K	33-66W	90x110°	170lm/W	1530	67	25
276284	5700K	33-66W	90x110°	170lm/W	1530	67	25

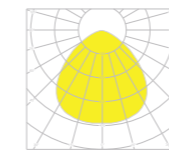

Model	CCT	Power	Beam angle	LM/W	L	W	H
276291	4000K	33-66W	120°	170lm/W	1530	67	25
276307	5700K	33-66W	120°	170lm/W	1530	67	25

# JUPITER TRUNKING AND FIXING KITS

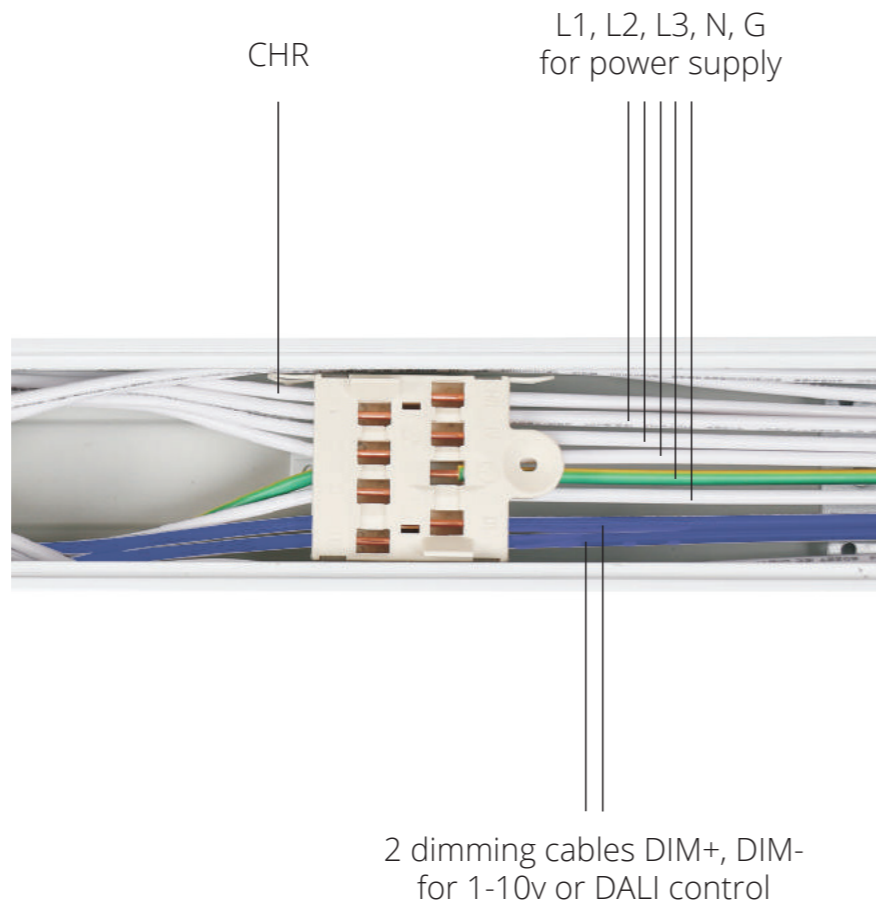
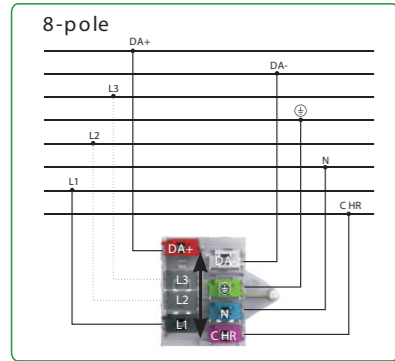
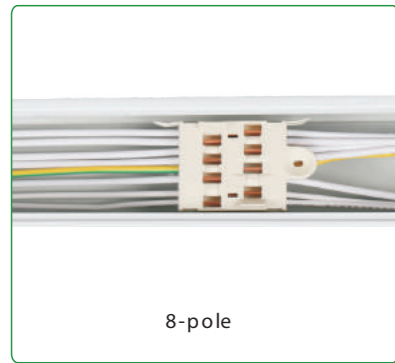

Model	Wires	Material	L	W	H
276222	6x2.5mm <sup>2</sup> + 2x1.5mm <sup>2</sup>	Steel	1530	65	45
276215	6x2.5mm <sup>2</sup> + 2x1.5mm <sup>2</sup>	Steel	3060	65	45
800000	6x2.5mm <sup>2</sup> + 2x1.5mm <sup>2</sup>	Steel	4590	65	45

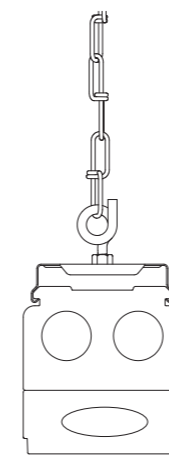
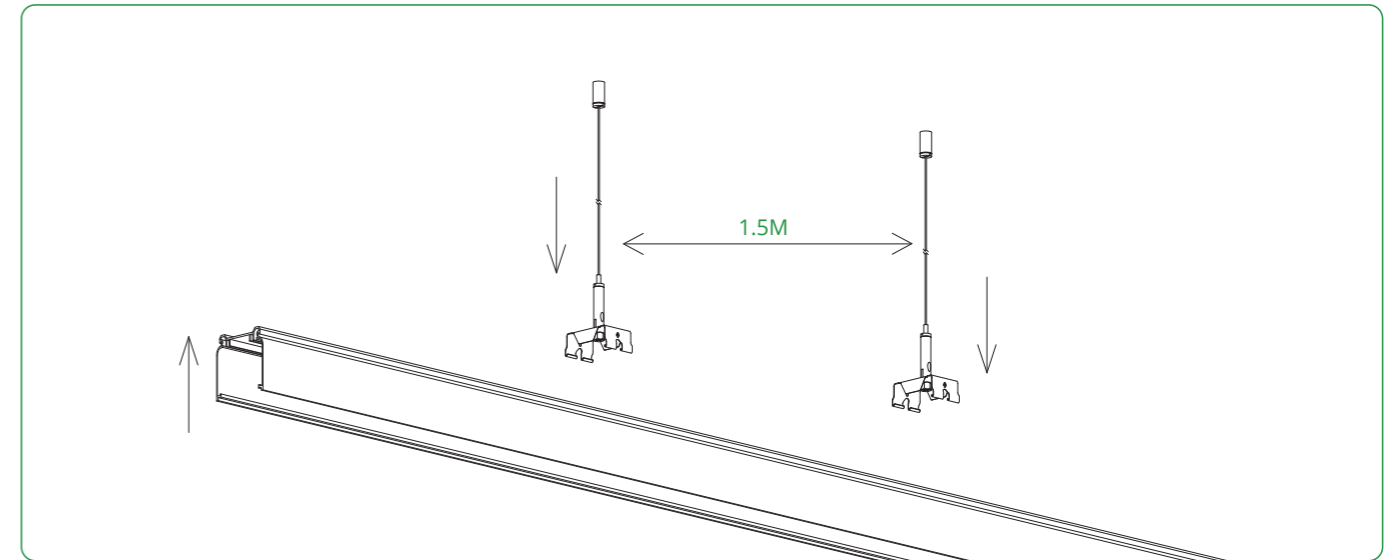
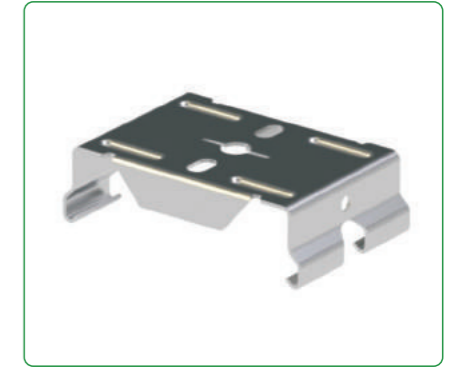
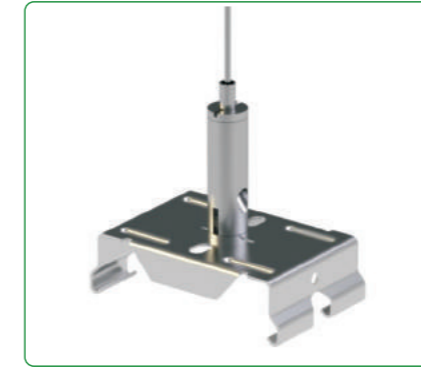

Chain  
801922

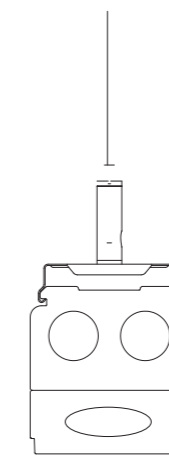

Steelcable  
276352

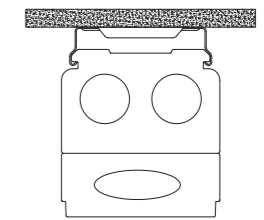

Surface Mounted  
276369

## JUPITER ACCESSOIRES

**End Cap**

272051



**AC input Terminal**

272051



**Cable protector**

272051



**End box**

272051



**PC cover**

272051

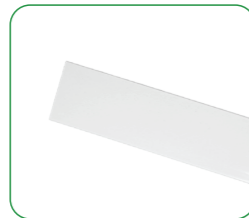

**Alu Cover**

272051

